WS-2801 Advanced Color Wireless Weather Station User Manual



Table of Contents

1	Introduction.....	2
1.1	What's New with the WS-2801.....	2
1.2	Features.....	2
2	Quick Start Guide.....	3
3	Getting Started.....	3
3.1	Parts List.....	3
3.2	Recommend Tools.....	4
3.3	Thermo-Hygrometer Sensor Set Up.....	4
3.4	Display Console.....	6
3.4.1	Display Console Layout.....	6
3.4.2	Display Console Set Up.....	7
3.4.3	Display Console Set Up.....	7
3.5	Sensor Operation Verification.....	8
3.6	Sensor Placement.....	9
3.7	Best Practices for Wireless Communication.....	9
4	Console Operation.....	10
4.1	Set Mode.....	10
4.1.1	Time Zones.....	12
4.2	Barometric Pressure.....	12
4.2.1	Barometric Pressure History.....	12
4.2.2	Relative Pressure Calibration.....	13
4.2.3	Relative vs. Absolute Pressure.....	13
4.3	Dew Point.....	13
4.4	Multiple Channel Selection.....	13
4.5	Alarms.....	14
4.5.1	View Alarm Time.....	14
4.5.2	Time Alarm Settings Mode.....	14
4.5.3	Cancelling the Alarm.....	14
4.5.4	Low Temperature Alarm.....	14
4.6	Calibration.....	15
4.7	Max/Min Mode.....	17
4.8	Other Console Features.....	17
4.8.1	Display Brightness.....	17

4.8.2	Weather Forecasting	18
4.8.3	Weather Forecasting Description and Limitations	18
4.8.4	Moon Phase	18
4.8.5	Pressure Tendency Arrows	19
4.8.6	Rate of Change of Pressure Graph	19
4.8.7	Resynchronizing Lost Sensor	19
5	Glossary of Terms	20
6	Specifications	20
6.1	Wireless Specifications	20
6.2	Measurement Specifications	21
6.3	Power Consumption	21
7	Troubleshooting Guide	21
8	Accessories	23
9	Liability Disclaimer	23
10	FCC Statement	24
11	Warranty Information	24

1 Introduction

Thank you for your purchase of the Ambient Weather WS-2801 Wireless Color Weather Station. The following user guide provides step by step instructions for installation, operation and troubleshooting. To download the latest manual and additional troubleshooting tips, please visit:

<http://ambientweather.wikispaces.com/ws2800>

1.1 What's New with the WS-2801

The WS-2801 only supported one remote wireless sensor. The WS-2801 supports up to three wireless remote sensors.

1.2 Features

The WS-2801 features:

- Wireless outdoor and indoor humidity (%RH)
- Wireless outdoor and indoor temperature (°F or °C)
- Records min. and max. humidity
- Records min. and max. temperature
- Barometric pressure (inHg or hPa)
- Weather forecast
- Radio controlled (WWVB) automatic date and time or manual date and time
- 12 or 24-hour time display
- Perpetual calendar

- Time alarm with snooze
- Moon phase
- LED color backlight
- Wall hanging or free standing
- Supports up to three wireless remote sensors

2 Quick Start Guide

Step	Description	Section
1	Power up Remote Sensor	3.3
2	Power Up Display Console	3.4
3	Set Up or Program Display Console	4.1
4	Install Sensor	3.6
5	Calibrate Barometer	4.2 and 4.6

3 Getting Started

The WS-2801 weather station consists of a display console (receiver), thermos-hygrometer sensor and AC adapter.



Note: The power up sequence must be performed in the order shown in this section (remote transmitter first, display console second) to properly synchronize the remote sensor to the console.

3.1 Parts List

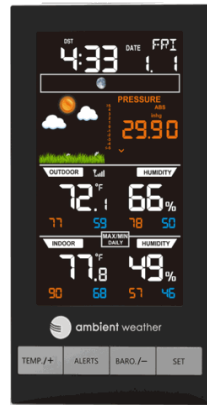
QTY	Item	Image
1	Display Console (WS-2801-C) Frame Dimensions (LxHxW): 6.36 x 3.39 x 0.86" (161.5 x 86 x 21.5 mm)	



QTY	Item	Image
1	Thermo-hygrometer transmitter (WH32M) Dimensions (LxHxW): 4.80 x 1.57 x 0.71" (122 x 40 x 18 mm)	
1	Manual	
1	Power Adapter	

Figure 1

3.2 Recommend Tools

- Hammer and nail for hanging remote thermo-hygrometer transmitter.

3.3 Thermo-Hygrometer Sensor Set Up

Remove the battery door on the back of the sensor, as shown in Figure 2.

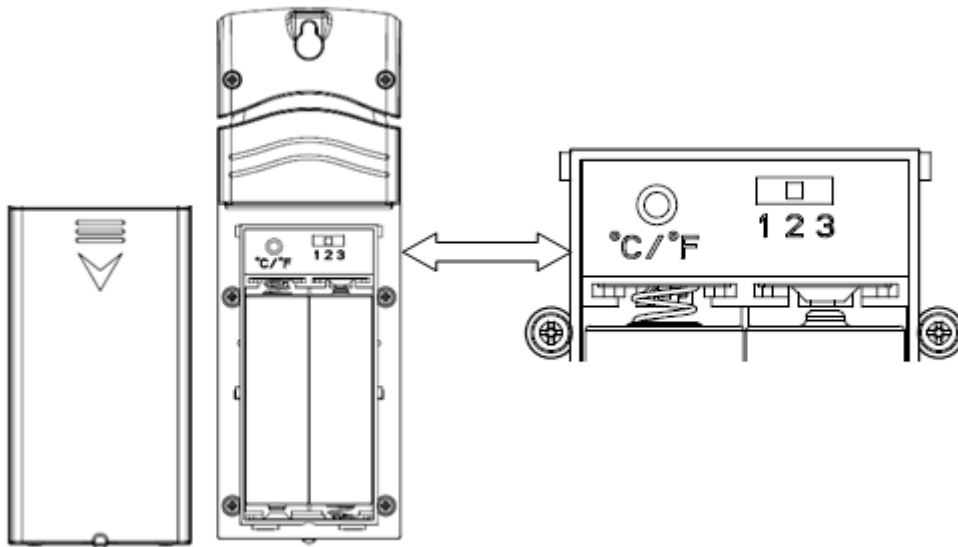

Figure 2

1. BEFORE inserting the batteries, switch the channel switch to the appropriate channel. If you have one sensor, set the switch to Channel 1. If you have two sensors, set the second sensor to Channel 2. If you own three sensors, set the third sensor to Channel 3.
2. To change the temperature units of measure, press the °C/°F button.
3. Insert two AA batteries.
4. After inserting the batteries, the remote sensor will display temperature and humidity and channel number on the display, as shown in Figure 3.

- 1 Temperature
- 2 Temperature Units of Measure
- 3 Channel Number
- 4 Humidity

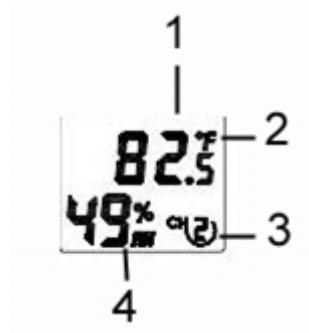



Figure 3

5. Close the battery door.

 Note: We recommend lithium batteries for cold weather climates, but alkaline batteries are sufficient for most climates. We do not recommend rechargeable batteries. They have lower voltages, do not operate well at wide temperature ranges, and do not last as long, resulting in poorer reception.

 Note: If the incorrect channel number is selected, change the channel number switch on the back of the sensor, and remove and reinsert the batteries for the change to take effect.

3.4 Display Console

3.4.1 Display Console Layout

The display console layout is shown in Figure 4.

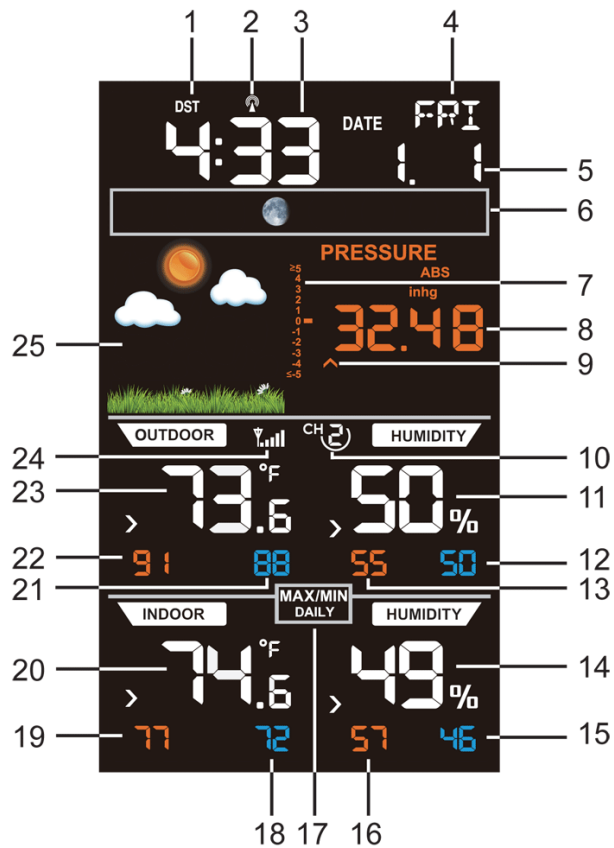

Figure 4

- | | |
|------------------------------------|--|
| 1. Daylight Savings Time | 14. Outdoor humidity |
| 2. Radio controlled reception | 15. Outdoor humidity |
| 3. Time | 16. Min indoor humidity |
| 4. Week day | 17. Max indoor humidity |
| 5. Date | 18. Min indoor temperature |
| 6. Moon phase | 19. Max indoor temperature |
| 7. Pressure rate of change | 20. Indoor temperature |
| 8. Barometric pressure | 21. Min outdoor temperature |
| 9. Barometric pressure trend arrow | 22. Max outdoor temperature |
| 10. Sensor channel number | |
| 11. Outdoor humidity | 23. Outdoor temperature |
| 12. Min outdoor humidity | 24. Transmitter signal strength |
| 13. Max outdoor humidity | 25. Weather forecast icon based on barometer |

3.4.2 Display Console Set Up

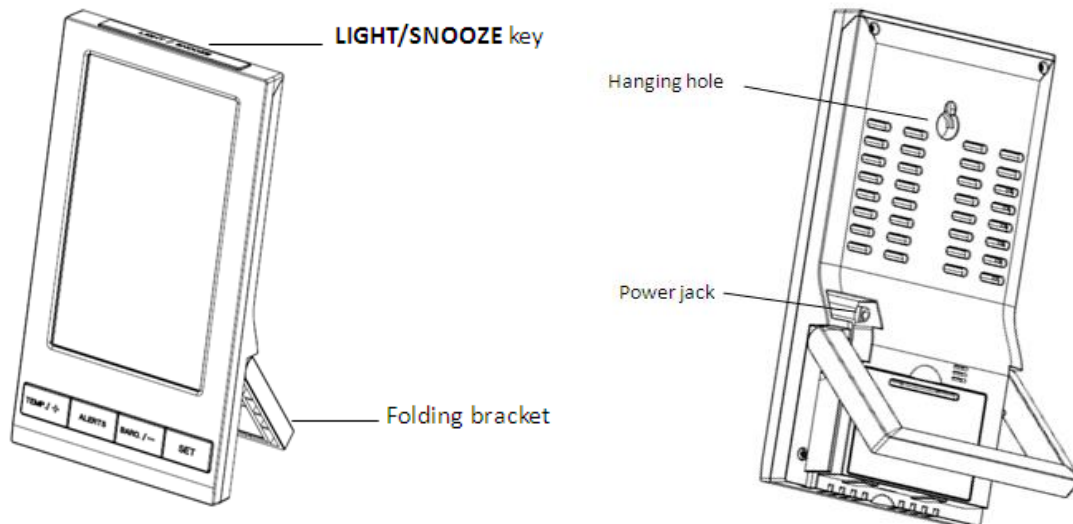



Figure 5

3.4.3 Display Console Set Up

Place the remote thermo-hygrometer about 5 to 10 feet away from the display console (if the sensor is too close, it may not be received by the display console).

1. Insert the power adapter into the power jack of the console, and plug in the adapter. The LCD display will beep once and then light up. The brightness selection is set to high when plugged into the adapter.
2. Remove the battery door on the back of the display. Insert three AAA (alkaline or lithium, avoid rechargeable) batteries in the back of the display console. Looking at the back of the unit (left to right), the polarity is (+) (-) for the top battery, (-) (+) for the middle battery and (+) (-) for the bottom battery.

 **Note:** To avoid permanent damage, please take note of the battery polarity before inserting the batteries.

3. Replace the battery door, and fold out the desk stand and place the console in the upright position, as shown in Figure 5.

 **Note:** The batteries are intended for back-up power only. The backlight will remain on for 5 seconds when on back up battery power only. Only when you use power adapter it will

the back-light be continuously on.

4. After initialization, the console will instantly display indoor temperature, humidity, barometer, moon phase, date and time. The remote search icon will turn on: 

Do not touch any buttons until the remote sensor reports in, otherwise the remote sensor search mode will be terminated and the search icon will turn off. When the remote sensor data has been received, the console will automatically switch to the normal mode, and all further settings can be performed.

3.4.4 Radio Controlled Clock (RCC)

Your console is equipped with the Radio Controlled Clock (RCC). The icon WWVB will appear above the time to signify this.

The RCC is received by the wireless transmitter, and passed to the console. After the remote sensor is powered up, the sensor will transmit weather data for 30 seconds, and then the sensor will begin radio controlled clock (RCC) reception.

During the RCC time reception period (maximum 10 minutes), no weather data will be transmitted to avoid interference.

If the signal reception is not successful (normally during the day due to solar interference), the sensor search will be cancelled, the outdoor temperature and humidity will update as normal, and the RCC search will automatically resume every two hours until the signal is successfully captured. The regular RF link will resume once RCC reception routine is finished. In some locations, RCC reception may take a couple of days to receive the signal. The temperature and humidity data will continue to transmit during this period.

Once the radio controlled time is received, the RCC reception icon  will turn on (reference Figure 4).

3.5 Sensor Operation Verification

Verify the indoor and outdoor humidity match closely with the console and sensor array in the same location (about 10' apart). The sensors should be within 10% worst case (the accuracy is $\pm 5\%$). Allow about 30 minutes for both sensors to stabilize.

Verify the indoor and outdoor temperature match closely with the console and sensor array in the same location (about 10' apart). The sensors should be within 4°F worst case (the accuracy is $\pm 2^\circ\text{F}$). Allow about 30 minutes for both sensors to stabilize.

3.6 Sensor Placement

It is recommended you mount the remote sensor outside on a north facing wall, in a shaded area, at a height at or above the receiver. If a north facing wall is not possible, choose a shaded area, under an eave.

Direct sunlight and radiant heat sources will result in inaccurate temperature readings. Although the sensor is weatherproof, it is best to mount in a well-protected area, such as an eave.

1. Use a screw or nail to affix the remote sensor to the wall, as shown in Figure 6.
2. Hang the remote sensor up on string, as shown in Figure 7.

 **Note:** Make sure the sensor is mounted vertically and not lying down on a flat surface. This will insure optimum reception. Wireless signals are impacted by distance, interference (other weather stations, wireless phones, wireless routers, TVs and computer monitors), and transmission barriers, such as walls. In general, wireless signals will not penetrate solid metal and earth (down a hill, for example).

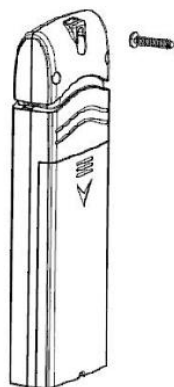

Figure 6

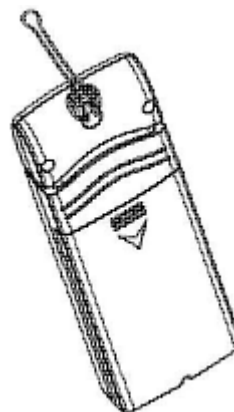

Figure 7

3.7 Best Practices for Wireless Communication

Wireless communication is susceptible to interference, distance, walls and metal barriers. We recommend the following best practices for trouble free wireless communication.

1. **Electro-Magnetic Interference (EMI).** Keep the console several feet away from computer monitors and TVs.
2. **Radio Frequency Interference (RFI).** If you have other 433 MHz devices and communication is intermittent, try turning off these other devices for troubleshooting purposes. You may need to relocate the transmitters or receivers to avoid intermittent communication.
3. **Line of Sight Rating.** This device is rated at 300feet line of sight (no interference, barriers or walls) but typically you will get 100feet maximum under most real-world installations, which include passing through barriers or walls.

4. **Metal Barriers.** Radio frequency will not pass through metal barriers such as aluminum siding. If you have metal siding, align the remote and console through a window to get a clear line of sight. The following is a table of reception loss vs. the transmission medium. Each “wall” or obstruction decreases the transmission range by the factor shown below.

Medium	RF Signal Strength Reduction
Glass (untreated)	5-15%
Plastics	10-15%
Wood	10-40%
Brick	10-40%
Concrete	40-80%
Metal	90-100%

4 Console Operation

 **Note:** The console has four keys for easy operation: **TEMP/+** key, **ALARM** key, **BARO/-** key and **SET/CH/CH** key. There are four program modes: Set Mode, Alarm Mode, Calibration Mode and Min/Max Mode.

Any program mode can be exited at any time by either pressing the **SNOOZE/LIGHT** key (on the top of the display console), or waiting for the 30-second time-out to take effect.

4.1 Set Mode

The Set Mode allows you to change date, time, units of measure and other important functions, as referenced in Figure 8.

To enter the Set Mode, press and hold the **SET/CH** key for two seconds (**SET/CH** + 2 seconds). To advance each command, press (do not hold) the **SET/CH** key.

Command	Function	Description	Settings
SET/CH + 2 seconds	BEEP	Turns on or off the beep with each keystroke	Press TEMP/+ or BARO/- to toggle OFF and ON
SET/CH	RST	Reset max/min daily at 12:00am (on) or manually (off)	Press TEMP/+ or BARO/- to toggle OFF and ON
SET/CH	ZON	Time Zone (TZ)	Press TEMP/+ to increase or BARO/- to decrease (reference Figure 9).
SET/CH	DST	Observe Daylight Savings Time (set to OFF in Arizona and Hawaii, ON everywhere else)	Press TEMP/+ or BARO/- to toggle OFF and ON
SET/CH	12H	12/24 Hour Format	Press TEMP/+ or BARO/- to toggle between 12 hour (12h) and 24 hour (24h) format
SET/CH	HR	Hour of Day	Press TEMP/+ to increase. BARO/- to decrease
SET/CH	MIN	Minute of Day	Press TEMP/+ to increase. BARO/- to decrease
SET/CH	M-D	Month Day Format	Press TEMP/+ or BARO/- to toggle between M-D (month/day) format and D-M (day/month) format
SET/CH	Y	Year	Press TEMP/+ to increase and BARO/- to decrease
SET/CH	M	Month of Year	Press TEMP/+ to increase and BARO/- to decrease
SET/CH	D	Day of Month	Press TEMP/+ to increase and BARO/- to decrease
SET/CH	°F	Temperature Units of Measure	Press TEMP/+ to toggle between °F and °C
SET/CH	inHg	Barometric Pressure Units of Measure	Press TEMP/+ to toggle between inHg and hPa
SET/CH	PRESSURE REL	Relative Pressure Calibration	Press TEMP/+ to increase. BARO/- to decrease. For details on relative barometric pressure calibration, reference Section 4.2.2.
SET/CH	NTH	Northern Hemisphere (NTH) or southern Hemisphere (STH) select	Press TEMP/+ to toggle between Northern and southern Hemisphere
SET/CH		Exit Set Mode	

Figure 8

4.1.1 Time Zones

Hours from GMT	Time Zone	Cities
-12	IDLW: International Date Line West	---
-11	NT: Nome	Nome, AK
-10	AHST: Alaska-Hawaii Standard CAT: Central Alaska HST: Hawaii Standard	Honolulu, HI
-9	YST: Yukon Standard	Yukon Territory
-8	PST: Pacific Standard	Los Angeles, CA, USA
-7	MST: Mountain Standard	Denver, CO, USA
-6	CST: Central Standard	Chicago, IL, USA
-5	EST: Eastern Standard	New York, NY, USA
-4	AST: Atlantic Standard	Caracas
-3	---	São Paulo, Brazil
-2	AT: Azores	Azores, Cape Verde Islands
-1	WAT: West Africa	---
0	GMT: Greenwich Mean WET: Western European	London, England
1	CET: Central European	Paris, France
2	EET: Eastern European	Athens, Greece
3	BT: Baghdad	Moscow, Russia
4	---	Abu Dhabi, UAE
5	---	Tashkent
6	---	Astana
7	---	Bangkok
8	CCT: China Coast	Beijing
9	JST: Japan Standard	Tokyo
10	GST: Guam Standard	Sydney
11	---	Magadan
12	IDLE: International Date Line East NZST: New Zealand Standard	Wellington, New Zealand

Figure 9

4.2 Barometric Pressure

4.2.1 Barometric Pressure History

While in normal mode, press **BARO/-** to check the barometric pressure history. Press the **BARO/-** button to switch to past 12hr/24hr/48hr/72hr average pressure. To exit the barometric pressure history mode, press the **SNOOZE/LIGHT** key (on the top of the display console), or wait 30

seconds for the timeout to take effect.

4.2.2 Relative Pressure Calibration

You will want to calculate your barometric pressure to an official reporting station in your area. Since barometric pressure does not drastically change in a 50 mile radius (unless the weather is rapidly changing), this method of calibration is acceptable.

To determine the relative pressure for your location, locate an official reporting station near you (the internet is the best source for real time barometer conditions, such as Weather.com or Wunderground.com), and set your weather station to match the official reporting station.

4.2.3 Relative vs. Absolute Pressure

To compare pressure conditions from one location to another, meteorologists correct pressure to sea-level conditions. Because the air pressure decreases as you rise in altitude, the sea-level corrected pressure (the pressure your location would be at if located at sea-level) is generally higher than your measured pressure.

Thus, your absolute pressure may read 28.62 inHg (969 mb) at an altitude of 1000 feet (305 m), but the relative pressure is 30.00 inHg (1016 mb).

The standard sea-level pressure is 29.92 in Hg (1013 mb). This is the average sea-level pressure around the world. Relative pressure measurements greater than 29.92 inHg (1013 mb) are considered high pressure and relative pressure measurements less than 29.92 inHg are considered low pressure.

4.3 Dew Point

While in normal mode, Press the **TEMP/+** key to view the Dew Point in the outdoor temperature field. If key idle 30 seconds, the display will return to normal mode.

To exit the Dew Point display mode, press the **SNOOZE/LIGHT** key (on the top of the display console), or wait 30 seconds for the timeout to take effect.

4.4 Multiple Channel Selection

If you have multiple wireless sensors, while in normal mode, press the **SET/CH** key to the different channels. Temperature, humidity, and MAX/MIN records will be displayed for each channel.

4.5 Alarms

4.5.1 View Alarm Time

While in normal mode, press the **ALARM** key to view the alarm time. The alarm icon will be displayed in the time field.

4.5.2 Time Alarm Settings Mode

To enter the Alarm Mode, press and hold the **ALARM** key for two seconds (**ALARM** + 2 seconds). To advance each command, press (do not hold) the **SET/CH** key.

Command	Function	Description	Settings
ALARM + 2 seconds	Alarm Hour	Set the Alarm Hour Time	Press TEMP/+ or BARO/- to increase or decrease the alarm hour.
SET/CH	Alarm Minute	Set the Alarm Hour Minute	Press TEMP/+ or BARO/- to increase or decrease the alarm minute.
SET/CH	ALARM ON/OFF	Turn the Time Alarm On or Off.	Press TEMP/+ to toggle between Time Alarm ON and Time Alarm Off
SET/CH	LOW Alarm	Turn the LOW Temperature Alarm On or Off	Press TEMP/+ to toggle between Time Alarm ON and Time Alarm Off
SET/CH		Exit Set Mode	

Figure 10

4.5.3 Cancelling the Alarm

If the time alarm sounds, press the any key to silence the alarm. Press the **LIGHT/SNOOZE** key to enter snooze mode.

The low temperature alert will reset automatically once the value has fallen into the low temperature alert range.

4.5.4 Low Temperature Alarm

The low temperature alarm sounds when the outdoor is between -3 °C and +2 °C (26.6 °F and 35.6 °F). The LO temperature icon  will appear and flash on the console. If the BEEP is switched on, an audible alert will also activated when the low temperature alert occurs.

If you own more than one sensor, the low temperature alarm will activate for any one of the sensors.



Figure 11

4.6 Calibration

While in the normal node, press and hold the **SET/CH** and **BARO/-** keys for five seconds to enter calibration mode (note: the **SET/CH** mode will appear after three seconds. Continue pressing the two keys until you see the **CAL** icon appear in the upper right hand corner of the display).

Enter the calibration offset to match the calibration source.

Command	Function	Description	Settings
SET/CH and BARO/- + 5 seconds	CH 1 TEMP	Calibrate the channel 1 temperature	Press TEMP/+ or BARO/- to increase or decrease the outdoor temperature offset.
SET/CH	CH 1 HUMIDITY	Calibrate the channel 1 humidity	Press TEMP/+ or BARO/- to increase or decrease the outdoor humidity offset.
SET/CH	CH 2 TEMP	Calibrate the channel 2 temperature	Press TEMP/+ or BARO/- to increase or decrease the outdoor temperature offset.
SET/CH	CH 2 HUMIDITY	Calibrate the channel 2 humidity	Press TEMP/+ or BARO/- to increase or decrease the outdoor humidity offset.
SET/CH	CH 3 TEMP	Calibrate the channel 3 temperature	Press TEMP/+ or BARO/- to increase or decrease the outdoor temperature offset.
SET/CH	CH 3 HUMIDITY	Calibrate the channel 3 humidity	Press TEMP/+ or BARO/- to increase or decrease the outdoor humidity offset.
SET/CH	INDOOR TEMP	Calibrate the indoor temperature	Press TEMP/+ or BARO/- to increase or decrease the indoor temperature offset.
SET/CH	INDOOR HUMIDITY	Calibrate the indoor humidity	Press TEMP/+ or BARO/- to increase or decrease the indoor humidity offset.
SET/CH	PRESSURE	Calibrate the absolute and relative pressure	Press TEMP/+ or BARO/- to increase or decrease absolute and relative pressure offset.
SET/CH		Exit Set Mode	

Figure 12

Example 1:

The calibrated temperature from a red spirit thermometer, or actual temperature is 60.0 °F.

The uncalibrated or measured temperature is 58.7 °F.

Offset = Calibrated Temperature – Uncalibrated Temperature = 60.0 – 58.7 = 1.3 °F.

Enter the temperature offset +1.3 °F.

Example 2:

The calibrated absolute pressure from a calibrated pressure sensor, or actual absolute pressure is 28.61 inHg.

The uncalibrated or measured absolute pressure measured by the weather station is 28.66 inHg.

Offset = 28.66 – 28.61 = -0.05 inHg

Enter the absolute pressure offset -0.05 inHg

 **Note:** The absolute pressure offset will also affect the relative pressure. To adjust the relative pressure, only (independent of the absolute pressure), reference Section 4.1.

Normally, you would not calibrate the absolute pressure because it is difficult to obtain a calibrated source. The preferred method is to calculate relative pressure to an official source near you, as described in Section 4.2.2.

To exit the calibration mode at any time, press the **LIGHT/SNOOZE** button.

 **Note:** The calibration offset range limits are as follows:

Temperature: $\pm 9^{\circ}\text{F}$

Humidity: $\pm 9\%$

Relative: $\pm 10\text{hpa}$ ($\pm 0.295\text{ inHg}$)

4.7 Max/Min Mode

The Max/Min data is displayed below each parameter. The orange parameter on the left is the maximum value since the last reset, and the blue parameter on the left is the minimum value since the last reset.

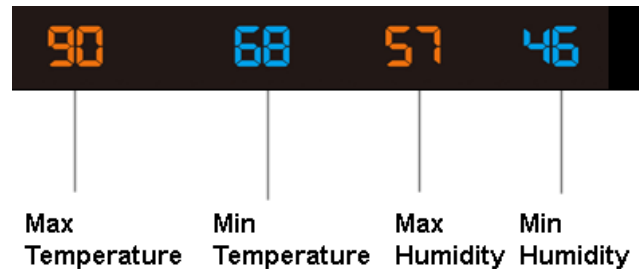

Figure 13

To clear all of the MAX/MIN records, press and hold the **TEMP/+** button for three seconds. Dashes will be displayed until the next update.

MAX/MIN records are cleared automatically at midnight. The MAX/MIN DAILY icon



will be displayed. To switch this feature off, reference Section 4.1.

4.8 Other Console Features

4.8.1 Display Brightness

Press the **LIGHT/SNOOZE** button to toggle the screen brightness between HIGH, MEDIUM and LOW.

4.8.2 Weather Forecasting

The five weather icons are Sunny, Partly Cloudy, Cloudy, Rainy and Stormy.

The forecast icon is based on the rate of change of barometric pressure. Please allow at least one month for the weather station to learn the barometric pressure over time.





Sunny	Partly Cloudy	Cloudy	Rainy	Stormy
				
Pressure increases for a sustained period of time	Pressure increases slightly, or initial power up	Pressure decreases slightly	Pressure decreases for a sustained period of time	Pressure rapidly decreases

Figure 14

4.8.3 Weather Forecasting Description and Limitations

In general, if the rate of change of pressure increases, the weather is generally improving (sunny to partly cloudy). If the rate of change of pressure decreases, the weather is generally degrading (cloudy, rainy or stormy). If the rate of change is relatively steady, it will read partly cloudy.

The reason the current conditions do not match the forecast icon is because the forecast is a prediction 24-48 hours in advance. In most locations, this prediction is only 70% accurate and it is a good idea to consult the National Weather Service for more accurate weather forecasts. In some locations, this prediction may be less or more accurate. However, it is still an interesting educational tool for learning why the weather changes.

The National Weather Service (and other weather services such as Accuweather and The Weather Channel) have many tools at their disposal to predict weather conditions, including weather radar, weather models, and detailed mapping of ground conditions.

4.8.4 Moon Phase

The following moon phases are displayed based on the calendar date and your northern vs southern hemisphere, as shown in Figure 15.

Northern Hemisphere:



New	Waxing Crescent	First Quarter	Waxing Gibbous	Full	Waning Gibbous	Third Quarter	Waning	New
-----	--------------------	------------------	-------------------	------	-------------------	------------------	--------	-----

Southern Hemisphere:





								
New	Waxing Crescent	First Quarter	Waxing Gibbous	Full	Waning Gibbous	Third Quarter	Waning	New

Figure 15

4.8.5 Pressure Tendency Arrows

The forecast trend arrow updates every 30 minutes. The trend reflects changes in pressure (1 hPa) over the past 3 hours.

Pressure is rising	Pressure is unchanged	Pressure is falling
^	>	v

Figure 16

4.8.6 Rate of Change of Pressure Graph

The rate of change of pressure graphic is shown to the left of the barometric pressure and signifies the difference between the daily average pressure and the 30 day average (in hPa).



Figure 17

4.8.7 Resynchronizing Lost Sensor

If the signal is lost between the remote sensor (or transmitter) and the display console (or the receiver), to resynchronize, while in normal mode, Press and hold **SET/CH** and **TEMP/+** button for 5 seconds, to register the outdoor transmitter. The sensor search icon will flash.

Please wait several minutes for the remote sensor reports in. Do not touch any buttons until synchronization is complete.

If the synchronization fails, reset the console by removing one battery from the display console, disconnect from AC power, wait 10 seconds, and reinsert the battery and reconnect AC power..

5 Glossary of Terms

Term	Definition
Accuracy	Accuracy is defined as the ability of a measurement to match the actual value of the quantity being measured.
Hygrometer	A hygrometer is a device that measures relative humidity. Relative humidity is a term used to describe the amount or percentage of water vapor that exists in air.
Range	Range is defined as the amount or extent a value can be measured.
Resolution	Resolution is defined as the number of significant digits (decimal places) to which a value is being reliably measured.
Absolute Barometric Pressure	Relative barometric pressure, corrected to sea-level. To compare pressure conditions from one location to another, meteorologists correct pressure to sea-level conditions. Because the air pressure decreases as you rise in altitude, the sea-level corrected pressure (the pressure your location would be at if located at sea-level) is generally higher than your measured pressure.
Relative Barometric Pressure	Measured barometric pressure relative to your location or ambient conditions.
HectoPascals (hPa)	Pressure units in SI (international system) units of measurement. Same as millibars (1 hPa = 1 mbar)
Inches of Mercury (inHg)	Pressure in Imperial units of measure. 1 inch of mercury = 33.86 millibars

6 Specifications

6.1 Wireless Specifications

- Line of sight wireless transmission (in open air): 300 feet, 100 feet under most conditions
- Frequency: 433 MHz

- Update Rate: 60 seconds for rain sensor and thermo-hygrometer sensor, 16 seconds for wind sensor.

6.2 Measurement Specifications

The following table provides specifications for the measured parameters.

Measurement	Range	Accuracy	Resolution
Indoor Temperature	-14 to 140 °F	± 1.8 °F	0.1 °F
	-10 to 60 °C	± 1 °C	0.1 °C
Outdoor Temperature	-40 to 140 °F	± 1.8 °F	0.1 °F
	-40 to 60 °C	± 1 °C	0.1 °C
Indoor Humidity	10 to 99 %	± 5% (only guaranteed between 20 to 90%)	1 %
Outdoor Humidity	10 to 99%	± 5% (only guaranteed between 20 to 90%)	1 %
Barometric Pressure	8.85 inHg to 32.48 inHg	± 0.09 inHg	0.01 inHg
	300 hpa to 1100 hpa	±3 hpa (only guaranteed between 700 to 1100hpa)	0.1hpa

Figure 18

6.3 Power Consumption

- Base station : 5V DC adaptor (included)
3 x AAA 1.5V Batteries (not included)
- Remote sensor : 2 x AAA Batteries (not included)
- Battery life: About 12 months for base station
About 12-24 months for thermometer-hygrometer sensor (use lithium batteries in cold weather climates)

7 Troubleshooting Guide

Problem	Solution
Wireless remote (thermo-hygrometer) not reporting in to console.	If any of the sensor communication is lost, dashes (---) will be displayed on the screen. To reacquire the signal, reference 4.8.7.
There are dashes (---) on the display console.	The maximum line of sight communication range is 300 feet and 100 feet under most conditions. Move the sensor assembly closer to the display console.

Problem	Solution
	<p>If the sensor assembly is too close (less than 5'), move the sensor assembly away from the display console.</p> <p>Make sure the remote sensor LCD display is working on both the console and the remote sensor.</p> <p>Install a fresh set of batteries in the remote thermo-hygrometer. For cold weather environments, install lithium batteries.</p> <p>Make sure the remote sensors are not transmitting through solid metal (acts as an RF shield), or earth barrier (down a hill).</p> <p>Move the display console around electrical noise generating devices, such as computers, TVs and other wireless transmitters or receivers.</p> <p>Move the remote sensor to a higher location. Move the remote sensor to a closer location.</p>
<p>Temperature sensor reads too high in the day time.</p>	<p>Make sure the thermo-hygrometer is mounted in a shaded area. The pre preferred location is a north facing wall because it is in the shade most of the day.</p> <p>Consider the following radiation shield if this is not possible: http://www.ambientweather.com/amwesrpatean.html</p>
<p>Indoor and Outdoor Temperature do not agree</p>	<p>Allow up to one hour for the sensors to stabilize due to signal filtering. The indoor and outdoor temperature sensors should agree within 3.6 °F (the sensor accuracy is ± 1.8 °F).</p> <p>Use the calibration feature to match the indoor and outdoor temperature to a known source.</p>
<p>Indoor and Outdoor Humidity do not agree</p>	<p>Allow up to one hour for the sensors to stabilize due to signal filtering. The indoor and outdoor humidity sensors should agree within 10 % (the sensor accuracy is ± 5 %).</p> <p>Use the calibration feature to match the indoor and outdoor humidity to a known source.</p>
<p>Display console contrast is weak</p>	<p>Plug into AC power. The console was not designed to run exclusively on batteries.</p>

8 Accessories

The following software and hardware accessories are available for this weather station at www.AmbientWeather.com.

Accessory	Description
Energizer AAA Lithium Battery (2-pack) - Batteries for Long Life and Cold Climates	AAA lithium batteries for cold weather climates.
Ambient Weather SRS100LX Temperature and Humidity Solar Radiation Shield	Solar Radiation Shield improves temperature accuracy for hot weather climates. Install over thermo-hygrometer.
Ambient Weather Humidity Calibration Kits	One step calibration kits for digital hygrometers use salt slurry formula to accurately calibrate the indoor and outdoor hygrometers.
Ambient Weather WS-2801-C Replacement Console	Order as many consoles or receivers as you like to place in different rooms around your house.
Ambient Weather WH32M Wireless Remote Sensors	The WS-2801 supports up to three wireless remote sensors.

9 Liability Disclaimer

Please help in the preservation of the environment and return used batteries to an authorized depot. The electrical and electronic wastes contain hazardous substances. Disposal of electronic waste in wild country and/or in unauthorized grounds strongly damages the environment.

Reading the “User manual” is highly recommended. The manufacturer and supplier cannot accept any responsibility for any incorrect readings and any consequences that occur should an inaccurate reading take place.

This product is designed for use in the home only as indication of weather conditions. This product is not to be used for medical purposes or for public information.

The specifications of this product may change without prior notice.

This product is not a toy. Keep out of the reach of children.

No part of this manual may be reproduced without written authorization of the manufacturer.

Ambient, LLC WILL NOT ASSUME LIABILITY FOR INCIDENTAL, CONSEQUENTIAL, PUNITIVE, OR OTHER SIMILAR DAMAGES ASSOCIATED WITH THE OPERATION OR MALFUNCTION OF THIS PRODUCT.

10 FCC Statement

Statement according to FCC part 15.19:

This device complies with part 15 of the FCC rules. Operation is subject to the following two conditions:

1. This device may not cause harmful interference.
2. This device must accept any interference received, including interference that may cause undesired operation.

Statement according to FCC part 15.21:

Modifications not expressly approved by this company could void the user's authority to operate the equipment.

Statement according to FCC part 15.105:

NOTE: This equipment has been tested and found to comply with the limits for a Class B digital device, pursuant to Part 15 of the FCC Rules. These limits are designed to provide reasonable protection against harmful interference in a residential installation. This equipment generates, uses and can radiate radio frequency energy and, if not installed and used in accordance with the instructions, may cause harmful interference to radio communications.

However, there is no guarantee that interference will not occur in a particular installation. If this equipment does cause harmful interference to radio or television reception, which can be determined by turning the equipment off and on, the user is encouraged to try to correct the interference by one or more of the following measures:

- Reorient or relocate the receiving antenna.
- Increase the separation between the equipment and receiver.
- Connect the equipment into an outlet on a circuit different from that to which the receiver is connected.
- Consult the dealer or an experienced radio/TV technician for help.

11 Warranty Information

Ambient, LLC provides a 1-year limited warranty on this product against manufacturing defects in materials and workmanship.

This limited warranty begins on the original date of purchase, is valid only on products purchased and only to the original purchaser of this product. To receive warranty service, the purchaser must contact Ambient, LLC for problem determination and service procedures.

Warranty service can only be performed by a Ambient, LLC. The original dated bill of sale must be presented upon request as proof of purchase to Ambient, LLC.

Your Ambient, LLC warranty covers all defects in material and workmanship with the following specified exceptions: (1) damage caused by accident, unreasonable use or neglect (lack of reasonable and necessary maintenance); (2) damage resulting from failure to follow instructions contained in your owner's manual; (3) damage resulting from the performance of repairs or alterations by someone other than an authorized Ambient, LLC authorized service center; (4) units used for other than home use (5) applications and uses that this product was not intended (6) the products inability to receive a signal due to any source of interference or metal obstructions and (7) extreme acts of nature, such as lightning strikes or floods.

This warranty covers only actual defects within the product itself, and does not cover the cost of installation or removal from a fixed installation, normal set-up or adjustments, claims based on misrepresentation by the seller or performance variations resulting from installation-related circumstances.

